

# BRIDGE

o o o o



## Wall-hung

Bridge is constructed to hang on the wall and is easily attached with screws. The shelf is neat and discrete and offers a lot of space.



## Adjustable shelves

Bridge makes it easy for you to be flexible and to change your mind. The shelves are easy to move around into new positions.

A new combination can give a whole new appearance and of course all shelves will be fastened safely into the uprights when finished. The shelving system gives you many options of style and expression.

Add door inserts for hidden storage and to give your shelf a more crafted look.

## TENZO COLOUR NO.

005 WHITE

024 BLACK

031 FOREST GREEN

954 OAK COLOUR

## MATERIAL

Shelves and uprights: Lacquered mdf and oiled oak coloured solid wood. Doors: Lacquered mdf. Door insert sides and inner shelf: Lacquered chipboard.

The right choice of screws depends on your wall material. Maxload 10 kg evenly spread per 99 cm shelf.

## BUILD YOUR OWN SHELF IN TWO EASY STEPS

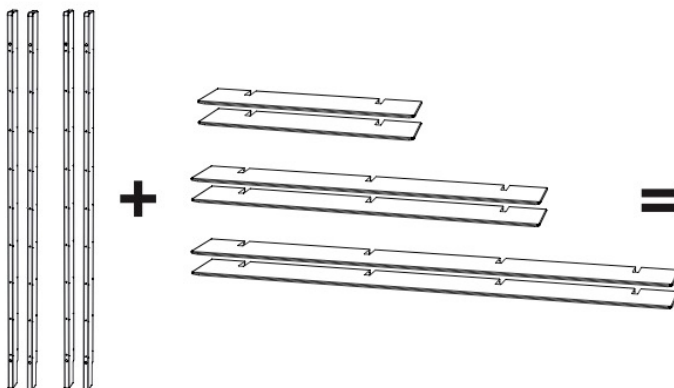

1. Choose uprights

2. Choose shelves

3. Done! Your unique wall shelf.  
Door inserts are optional.

# BRIDGE

**4102 Upright 2-p**

W:2,5 x D: 9 x H:190 cm



White - 005      Black - 024      Forest -031      Oak colour - 954

**4103 Upright 3-p**

W:2,5 x D: 9 x H:190 cm

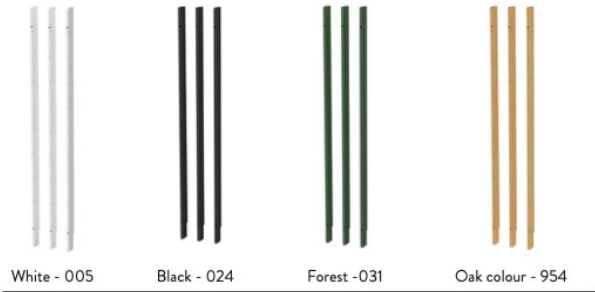

White - 005      Black - 024      Forest -031      Oak colour - 954

**4132 Shelf 2-p**

W:224 x D: 25 x H:2 cm

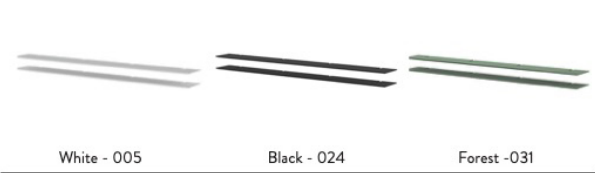

White - 005      Black - 024      Forest -031

**4133 Shelf 3-p**

W:224 x D: 25 x H:2 cm

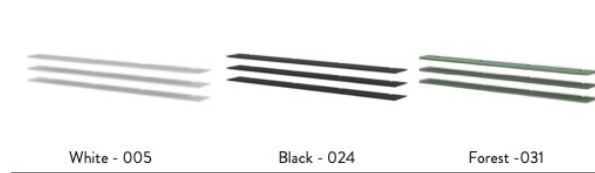

White - 005      Black - 024      Forest -031

**4122 Shelf 2-p**

W:162 x D: 25 x H:2 cm

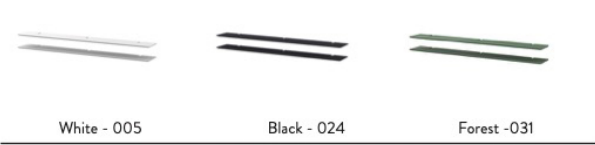

White - 005      Black - 024      Forest -031

**4123 Shelf 3-p**

W:162 x D: 25 x H:2 cm



White - 005      Black - 024      Forest -031

**4112 Shelf 2-p**

W:99 x D: 25 x H:2 cm

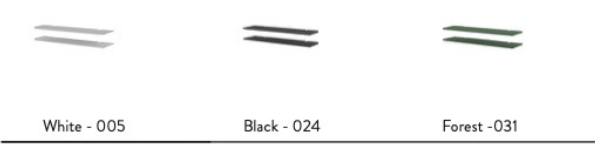

White - 005      Black - 024      Forest -031

**4113 Shelf 3-p**

W:99 x D: 25 x H:2 cm

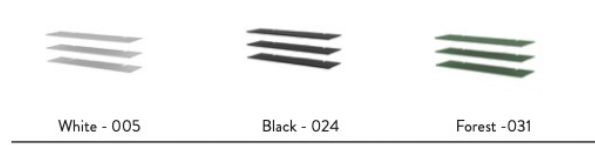

White - 005      Black - 024      Forest -031

**4105 Door insert**

W:68,4 x D: 22,5 x H:36,4 cm

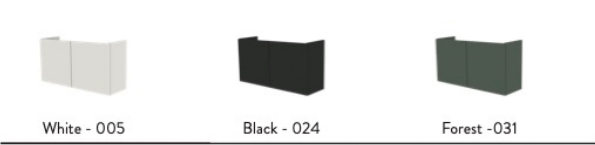

White - 005      Black - 024      Forest -031

# BRIDGE SELECTION - READY COMBINATIONS

## 4100 Shelf 3/5

W:162 x D:25 x H:190 cm



White - 005

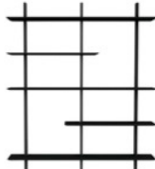

Black - 024



Forest - 031

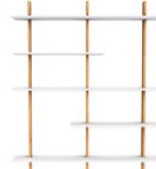

White/Oak - 605

## 4101 Shelf 4/5

W:224 x D:25 x H:190 cm



White - 005

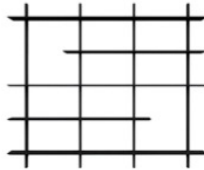

Black - 024



Forest - 031



White/Oak - 605



# BRIDGE

## AN INTERIOR INNOVATION

Bridge shelving system is carefully crafted and built from the idea of the creative human. With Bridge you can easily turn your wall into an interior design element. Make your personal designer statement and show who you are. The shelves have plenty of room for all your beloved things, put your treasures together and display them or hide some things behind the doors.

The uprights of Bridge are available in both colours and wood structure. The shelves, made of painted mdf, are available in different colours and lengths which makes the system versatile. Just as simple as exciting – Bridge suites any living room, dining room, kitchen or bedroom. Decide the size and impress with a full wall or give the smaller space some love with this designer shelf. Bridge is the perfect shelf for any interior enthusiast.